



Southwest Energy Efficiency Project

Saving Money and Reducing Pollution through Energy Conservation

Windows and Window Treatments

By

Larry Kinney

Prepared for

U.S. Department of Energy

Building America Program

Through the

**Midwest Research Institute
National Renewable Energy Laboratory Division**

September 2004

Preface

This report on windows and window treatments is one in a series of technical briefs being prepared by the Southwest Energy Efficiency Project (SWEEP) in support of the U.S. Department of Energy's Building America Program. Its intended audience is builders and design professionals interested in employing technologies that will reduce energy costs in both new and existing housing stock. Feedback from all readers on the form and content of this report is welcome. A companion report, "Policies and Programs for Expanding the Use of High Efficiency Fenestration Products in Homes in the Southwest," is aimed at energy program policy makers, planners, and analysts. It includes information on energy and economic analyses associated with various levels of the penetration of energy-efficient window technology and associated policy options. Both reports are available for downloading at www.swenergy.org.

Windows and Window Treatments

Introduction

Windows are wonderful devices—they enable us to see outside of our homes, provide natural light, and may be opened to provide ventilation. But windows—particularly inefficient ones—are effectively holes in the insulated envelope through which a great deal of energy can flow. This tends to make energy meters run faster, ultimately resulting in higher utility bills. If a well-insulated wall ($R = 25$) has 15% of its area glazed with conventional insulating glass windows ($R = 2$), conductive losses through the windows are 2.2 times the conductive losses through the remainder of the wall. If the windows are not protected from direct beam sunlight, summertime heat gain through windows can be much larger. In climates predominated by cooling energy needs, even fairly energy-efficient windows can account for 25% of total energy use for space conditioning—40% or more if clear glazing is un-shaded.

The market for windows in the U.S. for both new and retrofit applications is quite robust. In 2003, 66.7 million residential window units were sold, 50 % for replacements or remodels and 44 % for new housing (the remaining 6 % were for manufactured housing and non-residential structures). As recently as 2001, half of the residential window units sold both nationally and in the mountain region which includes the Southwest were clear glass double pane units whose solar gain accounts for a substantial portion of air conditioning loads (AAMA/WDMA 2004).

Happily, the news is not all bad. In recent years, a number of technologies have been developed that improve the performance of window systems by a great deal over that of windows of just a few years ago. Further, through a combination of better energy codes, mastery of high-speed production techniques, and competitive market forces, the cost of more efficient windows has come down substantially. Accordingly, builders can now specify and install window systems that greatly improve the energy efficiency of the homes they build—and so do cost effectively. This saves the home owner many thousands of dollars over the lifetime of a new home while helping to control peak loads on the grid. This latter effect is important to all parties since it delays the need for building expensive new power plants and the transmission and distribution systems that necessarily accompany them.

Window Technology

Windows transfer energy by radiation, conduction, and convection. Under many conditions, radiation predominates. Our eyes see only a narrow range of wavelengths, slightly less than half of the solar spectrum. Figure 1 depicts the irradiance from the sun as a function of wavelength after it has been filtered by passing through the atmosphere. Note that the peak of our eye's sensitivity curve (around 0.6 micrometers which we call yellow) corresponds closely with the peak of the sun's output.

Figure 1. Irradiance of the sun versus wavelength

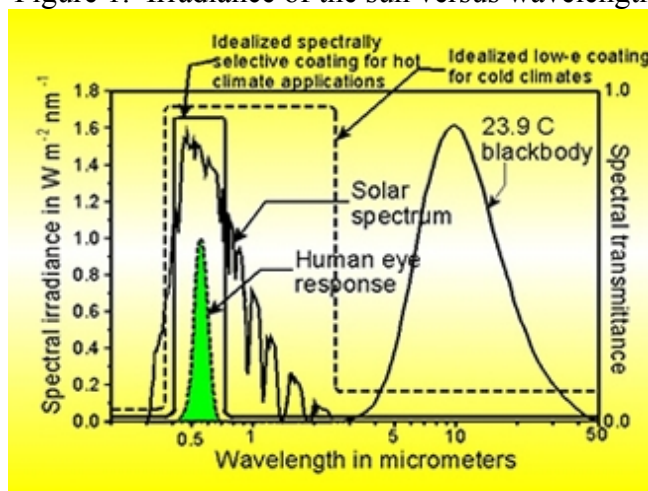

Source: Ross McCluney, Florida Solar Energy Center

Over the last several decades, manufacturers have developed the means to produce windows that selectively filter portions of the spectrum. The technique involves depositing very thin layers of metal on a surface of glass or a plastic substrate, typically using a sputtering process in a partial vacuum. First generation systems resulted in “low-E” coatings or films that are highly reflective of long wavelength radiation associated with room temperatures. Windows with conventional low-E coatings thus let through most of the sun’s radiation, but reflect radiation from room temperature sources (75°F is illustrated in the figure, with dashed lines illustrating the filtering action of low-E coatings.) The result is good performance of the window system in the wintertime since it lets in the whole spectrum of solar radiation yet keeps in radiation from objects around room temperatures.

Newer “second generation” window technology can be much more carefully tuned to filter just the wavelengths desired. For example, it is possible to filter only the infrared and ultraviolet portions of the spectrum while allowing most of the visible portions to be transmitted. This “spectrally selective” property is illustrated by the solid line in Figure 1. The resulting window performance is much better adapted to the Southwest, where cooling concerns are primary. This style of window keeps out a large portion of the radiation that would result in heat the air conditioner would have to remove, while allowing unobstructed viewing and substantial daylight.

These considerations give rise to two useful terms:

- **Solar heat gain coefficient (SHGC)** is the fraction of solar heat transmitted through a window system (plus absorbed energy that ends up supplying heat inside) with respect to the amount of solar heat that would flow through an unimpeded opening of the same size. It is a dimensionless number that can range between 0 and 1. SHGC’s of clear single and double-glazed window systems run from 0.7 to 0.9, whereas windows with spectrally-selective glazings typically run from 0.2 to 0.5.

- **Visual transmittance (V_t)** is the fraction of visible light transmitted through a window system with respect to the amount of visible light that would flow through an unimpeded opening of the same size. It is also a dimensionless number that can range between 0 and 1. V_t s of clear single and double-glazed glass run from 0.8 to 0.9, whereas heavily-tinted glass can have a V_t of 0.1 or even lower. Double-glazed spectrally-selective glass typically runs from 0.4 to 0.7 V_t .

A typical spectrally-selective window system suitable for the Southwest might have a V_t of 0.55 and a SHGC of 0.35. This window would perform over twice as well at keeping out solar heat than a conventional low-E window system, and is sometimes referred to as “double low-E” system, “southern low-E,” or “low solar gain low-E” system. Here, we adopt the latter convention. **A check of the SHGC is the best way of being sure that a window is indeed a low solar gain low-E unit.** This has become easy to do owing to the window and door labeling process of the National Fenestration Rating Council (NFRC; see NFRC.org). Sticky-backed labels are prominently displayed on doors and windows and include five figures of merit related to energy performance.

Windows also lose energy by conduction and convection. Insulation performance in walls and ceilings, for example, is usually given as an R-value, which is a measure of the resistance to heat flow that occurs because of the temperature difference across the two sides of a surface. During cold weather, windows with high insulation values are significantly warmer on the inside surface than are windows with low insulation values. This provides several benefits: moisture from condensation is reduced or eliminated, occupant comfort is increased, thermostat setpoints can be lowered, and the home’s heating system may be downsized. During the summer, well-insulated windows (particularly those that also have low SHGCs) are more comfortable, thereby allowing for higher thermostat set points and downsizing of the cooling system.

The conductivity of window systems, the **U-factor**, is the measure of choice in rating window systems. The lower the U-factor, the better. The U-factor is the reciprocal of R-value and is the rate of heat loss through a window *system* (which counts its frame) measured in Btu per hour per square foot per degree Fahrenheit ($\text{Btu}/\text{h}\cdot\text{ft}^2\cdot^\circ\text{F}$). **U-value** has the same units, but refers to the conductivity through the center of glass only. Unlike the ratings for insulation products, window U-factors and U-values include the effects of indoor and outdoor air films.

Glass itself is a fairly good conductor (a bad insulator), so its U-factor is quite high (and R-value low). When part of a single-glazed window system, most of the R-value of the system results from the still air layer immediately next to the pane on the inside and the not-so-still air space on the outside. Adding more layers of glazing (or suspended film) adds more still air spaces. Substituting an inert gas for air lowers the U-factor of the space even more.

Spacing between layers is somewhat important, as illustrated in Figure 2. When too close together, conductive losses tend to predominate, but when too far apart, convective loops develop and the resulting air movement causes higher losses. Spacing of roughly half an inch approaches optimal for air and argon-filled windows, whereas about 0.25 to 0.4 of an inch works best with krypton fills. Krypton achieves the best energy and comfort performance but is

somewhat more expensive than the other inert gases used in window systems. While air and argon fills are quite common, only a small number of products sold include krypton gas fill.

Figure 2. Center-of-Glass U-Value for Vertical Double (left) and Triple (right) Pane Glazing Units. The x-axes indicate gap width in inches.

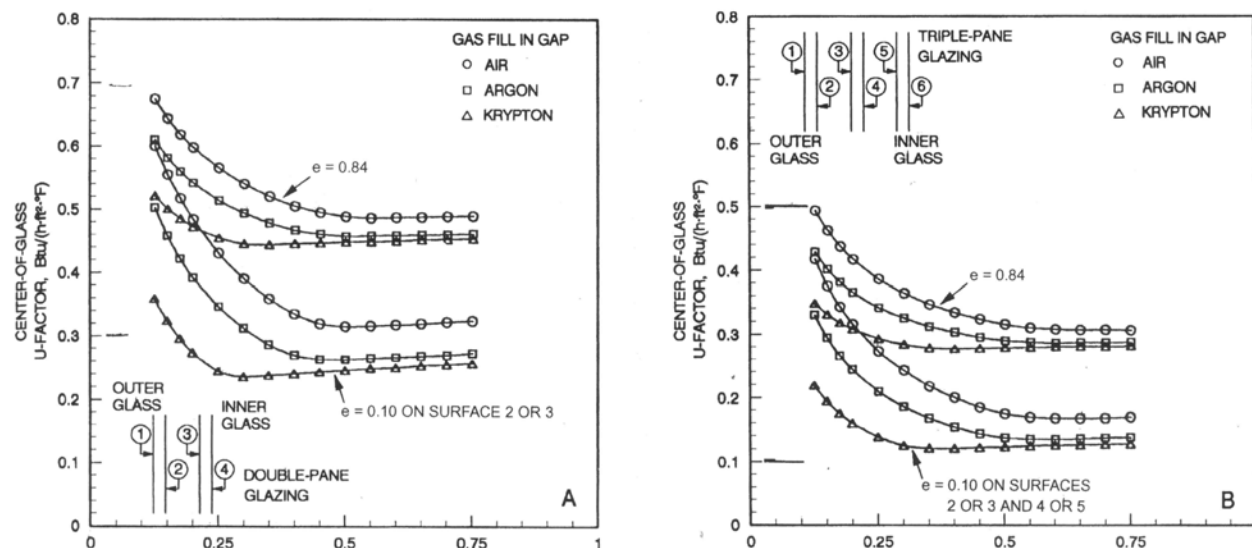

Source: 2001 ASHRAE Handbook of Fundamentals, p 30.3

The figure shows the conventions in numbering surfaces of multiple-glazed units. The outermost lite of an insulated glass unit is termed surface 1 and the innermost lite of a triple glazed unit is termed surface 6. A double-glazed window with a low-E coat on surface 3 is best for optimizing wintertime performance, whereas better summertime performance results from the low-E coat on surface 2. Hopefully a manufacturer will design a simple system for flipping the window (or at least its glazing) in the spring and fall.

Note also that the above figure refers to “center-of-glass” U-factor. Since insulating glass units are put together with continuous spacers, the edges of a window are usually more conductive than the center. The worst case is when spacers are made of aluminum, but thermally-insulating mastics used in the assembly of modern window systems relieve some of the conductive losses. Spacers made of foam, butyl, or other more insulating material are better still.

Window frames are typically built of steel, aluminum, vinyl, wood, or a combination of several materials. Steel is mainly used in commercial and institutional buildings. A number of manufacturers use wood that is “clad” with aluminum or vinyl at critical points to ensure smooth sliding and extend the life of the window system. Aluminum is light, lasts a long time, can be painted, and can be extruded inexpensively to form complex profiles. Accordingly, low-cost aluminum window frames are in wide use in the Southwest. However, aluminum is an excellent thermal conductor, so windows with aluminum frames which are not “thermally broken” result in both energy waste and discomfort. Happily, there are several techniques for achieving aluminum frames with a strategically-placed thermal break, thereby lowering the U-values of frame members by a factor of more than three over non-thermally broken frames (Figure 3).

Figure 3. Thermally-Broken Aluminum Window Frame. The complex aluminum extrusions shown include clamp-like elements that accommodate a low-conductivity hard vinyl shape. This shape firmly holds the inside extrusion to the outside extrusion without sacrificing mechanical integrity.

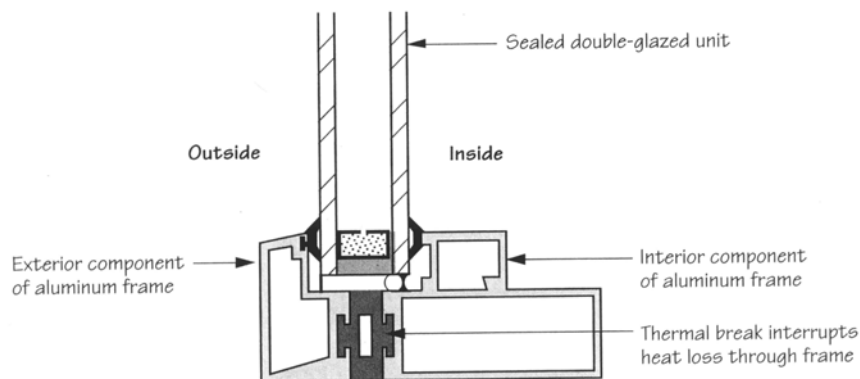

Source: Carmody et al, 1996

There are a number of manufacturers that produce middle-of-the-line wood, vinyl-clad wood, and vinyl windows aimed at the production home and replacement markets. Although their product literature doesn't emphasize energy features, the differences in cost between new windows unlikely to perform well in the Southwest and those which will perform reasonably well is quite small. For example, Pella produces an attractive 15 square foot double glazed wood window with a U-factor of 0.54 and a SHGC of 0.61 which Lowe's sells for \$208. The same model with an argon fill and spectrally-selective coating has a U-factor of 0.36 and a SHGC of 0.33—and it costs \$229, just over \$15 per square foot. The extra \$1.40 per square foot will have reasonable payback periods (2.8 years in Phoenix assuming a new window on each facade, 3.3 years in Denver, where the higher SHGC window is used on the south for better passive solar performance in the winter) and produce substantially better comfort.

It is possible to build quite good windows whose performance is better than these. Some of the techniques for achieving this end are illustrated in Figure 4.

Figure 4. Techniques for Achieving Very High Performance Window Systems

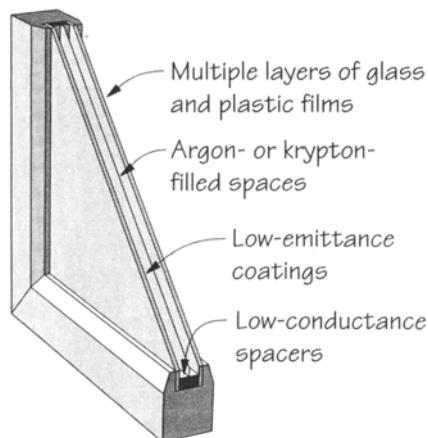

Source: Carmody et al, 1996

Instead of using multiple glazings, one or another of whose surfaces are coated, a number of manufacturers include Heat Mirror™ between glass lites. This is a thin film coated with a few hundred molecules thick of one or another metal oxides which variously affect the overall conductive properties of the window systems and their transmissivity in the visible and in the other parts of the spectrum. As a consequence, without using inert gases (only air) a number of manufacturers that use Heat Mirror produce window systems that yield U-factors and SHGCs of 0.16, while having visible transmittances of 0.43. These quasi triple-glazed units have the advantage of weighing no more than double-glazed units, although they do cost on the order of 30 % more for the glazing system than do standard low solar gain low-E window systems. However, since they need to have higher-width framing systems, they are typically supplied with high-end frames, which usually means that the whole window system costs roughly twice as much as double-glazed units.

Energy Loss or Gain as a Function of Window Type and Window Orientation

It has been observed that the façade with the greatest number of windows on a production built home tends to face the back yard, whatever its orientation. However, energy gains and losses through windows are a strong function of orientation (as well as of U-factor and SHCG, of course).

To get a feel for the effect of orientation for windows of different characteristics, it is useful to take several snapshots. All six of the bar charts shown in Figure 5 on the following page depict per-square foot solar gains and conductive losses in Btus for a single 24 hour day with clear skies at 40 degrees north latitude (approximately the latitude of Denver, Reno, and Salt Lake City.) The three figures in the left column (5a-5c) depict conditions for the 21st of January, with an average temperature of 20°F. Figures 5d-5f on the right depict conditions for the 21st of July, with an average temperature of 85°F. Net gains help in the winter and hurt in the summer.

The case of single-glazed clear windows is shown here to illustrate the difference between its performance and the performance of windows whose U factors and SHGCs make them much better candidates for both new and retrofit applications. Such windows are no longer used in new construction, but unhappily, single-glazed clear windows are still frequently found on many older homes in the Southwest, as are double-glazed clear windows with high SHGCs.

The reader is urged to be cautious in examining the plots in Figure 5 because the y-axes have different calibrations.

Figure 5a. January 21, single glazing, SHGC = 0.9; U = 1.0; loss = 1830 Btu/sq ft/day

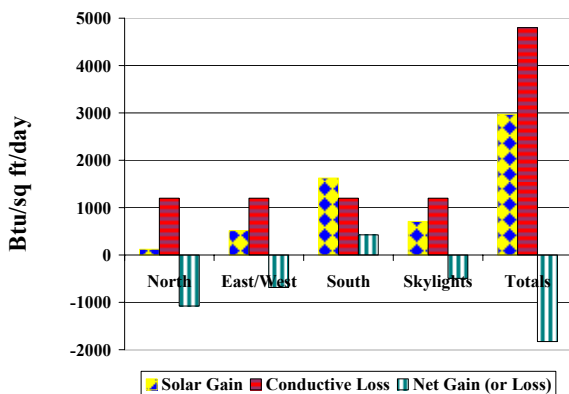

Figure 5d. July 21, single glazing, SHGC = 0.9; U = 1.0; gain = 5931 Btu/sq ft/day

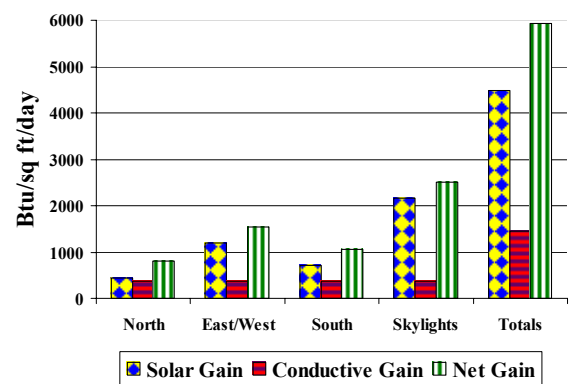

Figure 5b. January 21, double glazing, gas fill, SHGC = 0.38; U = 0.3; loss = 186 Btu/sq ft/day

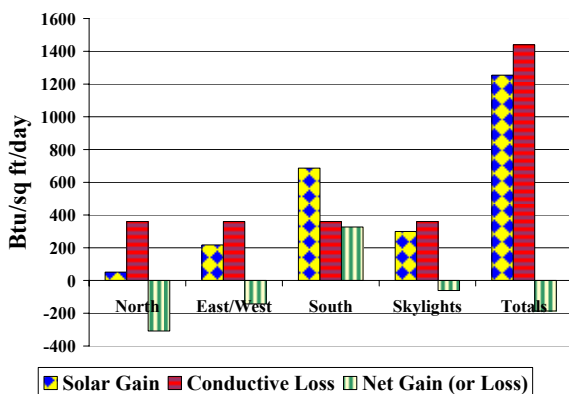

Figure 5d. July 21, double glazing, gas fill, SHGC = 0.38; U = 0.3; gain = 2,328 Btu/sq ft/day

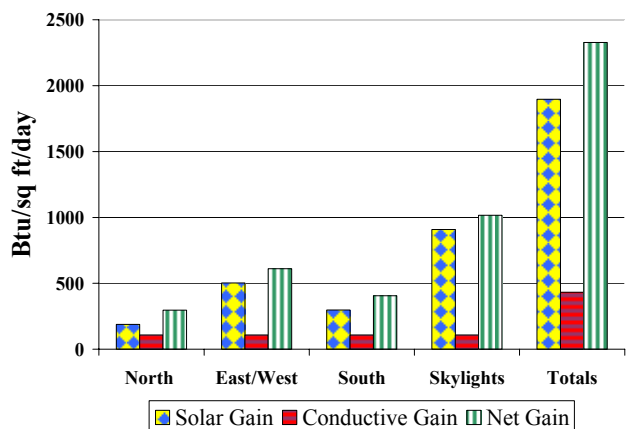

Figure 5c. January 21, double glazing, gas fill, SHGC = 0.38 (South 0.72); U = 0.3, gain = 220 Btu/sq ft/day

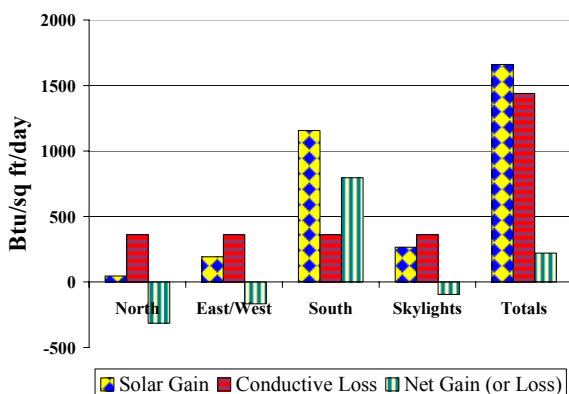
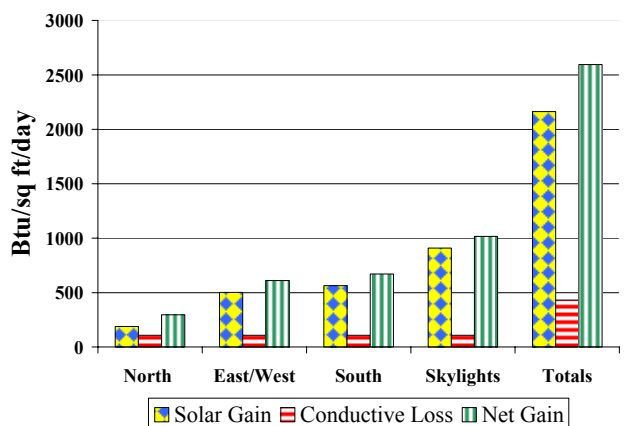

Figure 5f. July 21, double glazing, gas fill, SHGC = 0.38 (South 0.72), U = 0.3; gain = 2,594 Btu/sq ft/day



. These plots reveal a number of trends:

- Single-glazed windows with high SHGC (0.9) and U-factor (1.0) are net losers in all directions both summer and winter except for the south in the winter (Figures 5a and 5d). They are particularly poor performers in the summer. With 270 square feet of evenly-distributed glazing and an overall coefficient of performance (COP) of 3 for the cooling system, 40 kWh of cooling would be necessary to meet the window load on this single bright day in July.
- The case of low SHGC (0.38) and low U-factor (0.3) in all directions is still a small net loser on the bright January day because no facades except for the south have enough solar gain to make up for losses (Figures 5b and 5e). However, net losses in the winter are a factor of 10 less than the case of single glazing. Summertime cooling loads are about 40% those of the single glazed case; 16 kWh of cooling energy would be required for the bright day in July.
- The case shown in Figures 5c and 5f has the same glazing as the case above, but the south-facing glazing has a SHGC of 0.72 instead of 0.38. This gives better wintertime performance, allowing the entire glazing system to produce a net gain. There is a slight penalty paid in the summer of course, 17 kWh of cooling energy would be required for the bright day in July, 1 kWh more than in the case with low SHGC glazing.
- Skylights are net thermal losers in the winter and account for quite substantial solar gains in the summer. Exterior netting in the summer can limit solar gain while retaining a measure of natural illumination.

It is useful to examine the effect of adding shading devices (overhangs, awnings, fins) for the mid-summer case of the three windows systems. Table 1 assumes that such devices are 90% effective in shading direct beam sunlight.

Table 1. The Effect on July 1 of Adding 90% Effective Shading Devices to the Window Systems in Figure 5.

Parameter	U = 0.1 SHGC = 0.9	U = 0.3 SHGC = 0.38	U = 0.3 SHGC = 0.38 (South SHGC = 0.72)
Solar Gain (Btu/ft ² /day)	2339	988	1253
Conductive Gain (Btu/ft ² /day)	1080	324	324
Total Gain (Btu/ft ² /day)	3419	1312	1577
Total Gain w/ Shading (Btu/ft ² /day)	1314	423	449
Savings (Btu/ft ² /day)	2105	889	1128
Savings (%)	62%	68%	72%

This analysis shows that adding overhangs, awnings, or other external shading devices (living, such as trees and vines, as well as mechanical) to block direct beam sunshine substantially lowers the cooling loads for all glazing types. Of course, the absolute beneficial effect of shading

devices is most pronounced for window systems with particularly high SHGCs, approximately twice that of the more efficient glazing systems.

These considerations show that *judicious use of overhangs and other external shading devices in combination with SHGCs tuned to direction can produce excellent overall performance.*

Annual Performance in the Southwest

RESFEN (for “residential fenestration”) is an hourly simulation program based on DOE 2.1E software developed at the Lawrence Berkeley National Laboratory. It is a tool for evaluating the energy consequences of various fenestration systems in a number of cities using typical meteorological year weather data. We made a number of runs on homes in Southwestern cities with RESFEN version 3.1 using windows of various characteristics. In all cases, we assumed single-story, frame, 2,000 square foot homes with 300 square feet of fenestration systems distributed evenly on the four facades of the homes. Homes in Albuquerque, Las Vegas, and Phoenix were assumed to have slab-on-grade construction; those in Cheyenne, Denver, and Salt Lake City had basements. The homes modeled in Albuquerque, Cheyenne, Denver, and Salt Lake City had ceilings insulated to R-38 and walls to R-19; ceilings in Las Vegas and Phoenix had R-30 insulation and walls of R-14 and R-11 respectively. Furnace seasonal efficiency was assumed to be 78 % and cooling systems 10 SEER. Duct leakage was set at 10% summer and winter.

We looked at six fenestration systems, whose characteristics are described below:

- A double pane insulating glass unit with clear glass and non-thermally-broken aluminum frame, overall window system U-factor = 0.79, SHGC = 0.68 (Clear 2 pane)
- A spectrally-selective, double-pane insulating glass unit with an overall window system U-factor of 0.5 and a SHGC of 0.4 (low solar gain low-E 2 pane)
- The same spectrally-selective, double-pane insulating glass unit above with the addition of (1) interior shades resulting in a SHGC multiplier of 0.8 in summer, no shades in winter, (2) two-foot exterior overhangs, and (3) exterior obstructions of the same height as the window 20 feet away that represent adjoining buildings or fences (Shaded low solar gain Low-E 2 pane)
- A spectrally-selective double-pane insulating glass unit with an overall window system U-value of 0.34 and a SHGC of 0.34 (Better low solar gain Low-EE 2 pane)
- A spectrally-selective triple pane insulating glass unit with an overall window system U-factor of 0.24 and a SHGC of 0.25 (Hi performance 3 pane)
- The low solar gain low-E 2 pane window with an exterior insulating shutter that brings the window system to a U-factor of 0.1 when closed (low solar gain low-E 2 pane with shutters). The shutter was assumed to be closed during night hours summer and winter and open during the days in winter, but selectivity closed during the summer by an automated system that shields windows from direct beam sunlight as the sun traverses the sky. It is assumed that the automated system is overridden by users 10 % of the time. During periods in which direct beam would otherwise enter the glazing of a given façade, SHGC was assumed at .05; otherwise at 0.4, the SHGC of the low solar gain low-E 2 pane window.

The shutters analyzed are still in prototype development stage and are not currently in production. However prototypes have been extensively tested summer and winter by a team from the Syracuse Research Corporation with funding from the U.S. DOE. The system achieves good air seals and results in system insulating values of above R-10 (U-factor of 0.1). The aim is to produce easily installable units for a builder cost of under \$30 per square foot. Current development work includes automating shutter operation via wireless technology (Figure 6).

Figure 6. Prototype of Outsider Insulating Shutters of the Kind Analyzed in RESFEN Simulations

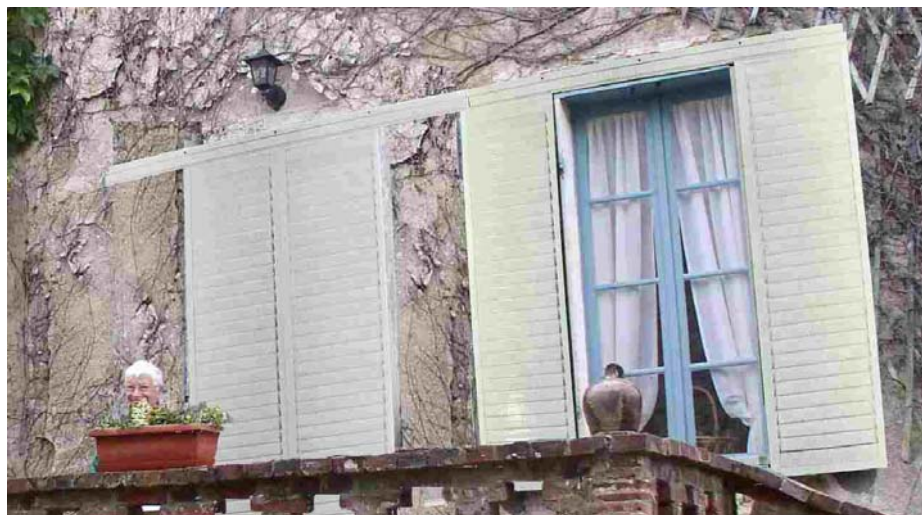

Cost analyses are based on the energy cost and weather data in Table 2. Note that cooling degree hours are shown instead of cooling degree days because this better reflects effects of temperatures on residential structures in the Southwest where clear skies result in quite substantial diurnal temperature swings, typically over 30 degrees F between afternoons and early mornings.

Table 2. Residential Electricity and Gas Costs and Weather in Southwest States

State	Elec \$/kWh	Elec \$/MBtu	Gas \$/Therm	Gas \$/MBtu	Heating Degree Days	Cooling Degree Hours
Arizona	0.074	21.68	1.31	13.13	1,444	54,404
Colorado	0.079	23.15	0.92	9.19	6,023	5,908
Nevada	0.090	26.37	1.06	10.60	2,535	43,153
New Mexico	0.083	24.32	0.99	9.93	4,415	11,012
Utah	0.066	19.34	0.99	9.93	5,805	9,898
Wyoming	0.065	19.05	0.94	9.35	7,315	2,087

Source: Energy Information Administration. Average statewide electricity costs as of February 2004, gas costs as of March 2004. Assumes 1 ft³ of gas = 860 Btu. Heating Degree Days and Cooling Degree Hours from ANSI/ASHRAE Standard 90.2 for cities analyzed.

Tables 3-7 show energy gains and losses that are **due to the window systems alone**. The last column expresses the percentage of total heating and cooling costs represented by window costs.

Table 3. Simulation Results of a Double Pane Insulating Glass Unit with Clear Glass and Aluminum Frame, U-factor = 0.79, SHGC = 0.68 (Clear 2 pane) (This table is provided for comparison purposes only. Clear glass is not recommended for use in either new or existing homes because of the cost effectiveness of high-performance low solar gain low-E glass.)

City	North		East and West		South		Totals				
	Cool kWh	Heat MBtu	Cool kWh	Heat MBtu	Cool kWh	Heat MBtu	Cool kWh	Heat MBtu	Peak kW	Annual \$	% of Total \$
Albuquerque	251	6.71	1219	2.35	465	-4.34	1935	4.72	1.35	\$192	37
Cheyenne	101	9.48	535	8.77	240	-1.78	876	16.47	1.48	\$214	26
Denver	168	7.1	910	6.5	431	-2.05	1509	11.55	1.62	\$225	36
Las Vegas	509	2.33	2317	0.95	924	-2.81	3750	0.47	2.55	\$339	51
Phoenix	652	1.22	2936	1.14	1308	-0.82	4896	1.54	2.88	\$383	54
Salt Lake	245	6.39	1214	7.18	502	-0.31	1961	13.26	2.06	\$262	37

Table 4. Simulation Results of a Spectrally-Selective, Double-Pane Insulating Glass Unit with a U-Factor of 0.5 and a SHGC of 0.4 (low solar gain low-E 2 pane)

City	North		East and West		South		Totals				
	Cool kWh	Heat MBtu	Cool kWh	Heat MBtu	Cool kWh	Heat MBtu	Cool kWh	Heat MBtu	Peak kW	Annual \$	% of Total \$
Albuquerque	143	3.67	711	1.69	263	-2.86	1117	2.5	1	\$118	31
Cheyenne	49	6.68	259	6.43	113	-0.66	421	12.45	1.01	\$144	22
Denver	100	5.21	493	4.75	221	-1.21	814	8.75	1.14	\$145	28
Las Vegas	309	1.8	1382	-0.8	547	-2.71	2238	-1.71	1.67	\$183	37
Phoenix	400	0.94	1760	0.71	774	-0.89	2934	0.76	1.83	\$227	42
Salt Lake	141	4.66	694	5.07	280	-0.18	1115	9.55	1.42	\$168	30

Table 5. Simulation Results of the low solar gain low-E 2 Pane Window Shown in Table 4 with Interior Shades, Two Foot Overhangs, and Obstructions in Summer, no Interior Shades in Winter (Shaded low solar gain low-E 2 pane)

City	North		East and West		South		Totals				
	Cool kWh	Heat MBtu	Cool kWh	Heat MBtu	Cool kWh	Heat MBtu	Cool kWh	Heat MBtu	Peak kW	Annual \$	% of Total \$
Albuquerque	53	4.06	269	4.2	63	-1.57	385	6.69	0.66	\$99	21
Cheyenne	10	7.44	46	10.17	11	1.34	67	18.95	0.65	\$184	21
Denver	32	5.74	148	7.63	39	0.18	219	13.55	0.76	\$142	24
Las Vegas	190	2.02	577	1.64	231	-2.26	998	1.4	1.1	\$105	22
Phoenix	241	1.08	892	1.22	336	-0.97	1469	1.33	1.12	\$126	26
Salt Lake	63	5.19	283	7.32	72	1.02	418	13.53	0.88	\$162	25

Table 6. Simulation Results of a Spectrally-Selective Double Pane Window with a U-factor of 0.34 and a SHGC of 0.34 (better low solar gain low-E 2 pane)

City	North		East and West		South		Totals				
	Cool kWh	Heat MBtu	Cool kWh	Heat MBtu	Cool kWh	Heat MBtu	Cool kWh	Heat MBtu	Peak kW	Annual \$	% of Total \$
Albuquerque	124	2.46	612	0.05	223	-2.16	959	0.35	0.81	\$83	19
Cheyenne	41	4.47	213	3.06	92	-1.78	346	5.75	0.89	\$76	11
Denver	83	3.52	410	2.11	181	-2.03	674	3.6	0.98	\$86	17
Las Vegas	261	1.19	1167	-0.59	463	-2.73	1891	-2.13	1.36	\$148	30
Phoenix	331	0.63	1485	0.21	652	-0.98	2468	-0.14	1.49	\$181	36
Salt Lake	122	3.16	592	2.58	237	-1.04	951	4.7	1.2	\$109	19

Table 7. Simulation Results of a Spectrally-Selective Triple Pane Insulating Glass Unit with a U-factor of 0.24 and a SHGC of 0.25 (Hi performance 3 pane)

City	North		East and West		South		Totals				
	Cool kWh	Heat MBtu	Cool kWh	Heat MBtu	Cool kWh	Heat MBtu	Cool kWh	Heat MBtu	Peak kW	Annual \$	% of Total \$
Albuquerque	92	1.82	447	-0.24	162	-2.54	701	-0.96	0.61	\$49	16
Cheyenne	28	3.28	133	2	58	-1.46	219	3.82	0.78	\$50	9
Denver	56	2.6	277	1.37	119	-1.66	452	2.31	0.82	\$57	13
Las Vegas	195	0.89	863	-0.66	339	-2.24	1397	-2.01	1.02	\$104	24
Phoenix	251	0.48	1103	0.07	474	-0.86	1828	-0.31	1.12	\$131	30
Salt Lake	87	2.33	415	1.72	168	-0.94	670	3.11	0.91	\$75	17

Table 8. Simulation Results of the low solar gain low-E 2 Pane Window Shown in Table 4 with an Exterior Insulating Shutter (low solar gain low-E 2 pane with shutters)

City	North		East and West		South		Totals				
	Cool kWh	Heat MBtu	Cool kWh	Heat MBtu	Cool kWh	Heat MBtu	Cool kWh	Heat MBtu	Peak kW	Annual \$	% of Total \$
Albuquerque	9	1.52	56	-2.15	26	-4.69	91	-5.32	0.22	-\$39	-13%
Cheyenne	1	2.88	6	-0.62	2	-4.11	9	-1.85	0.25	-\$38	-6%
Denver	5	2.29	29	-0.6	12	-3.76	46	-2.07	0.27	-\$31	-8%
Las Vegas	76	0.71	244	-1.51	104	-3.35	424	-4.15	0.49	\$3	0%
Phoenix	97	0.39	307	-0.18	137	-1.11	541	-0.9	0.56	\$25	7%
Salt Lake	18	2.03	74	0.17	30	-2.49	122	-0.29	0.38	-\$17	-4%

Table 3 shows that inefficient window systems (aluminum frames, clear glass, even if double pane) can account for 26 to 54 % of energy use for space heating and cooling and *cost* \$192 (in Cheyenne) to \$383 (in Phoenix) per year in a standard 2000 square foot air conditioned home in the Southwest. The use of better windows (with better frames and low-solar heat gain coefficients as shown in Table 6) can *cut energy use due to windows* by an average of 58%, from 53% (\$202 per year) in Phoenix to 64% (\$138 per year) in Cheyenne. Excellent windows, like the system shown in Table 7 *save* 66 % (\$252 per year) in Phoenix to 77 % (\$164 per year) in

Cheyenne with respect to the double-glazed clear windows of Table 3. Finally, the use of automated insulating shutters along with low solar gain Low-E results in even lower energy use and cost in all parts of the region (Table 8).

The use of quite low SHGC windows (or, fixed shading devices, for example) can further reduce energy use and cost in very hot climates, but not necessarily in colder climates (compare Table 6 and Table 7 results).

These results show that the type of window system makes a very big difference in the energy performance and cost to heat and cool dwellings in the Southwest. Note that cooling energy associated with the east and west facades is 1.5 to 2 times the cooling energy associated with the north and south facades, whether or not windows are equipped with shading devices.

Figure 6 illustrates differences in the annual cost of energy associated with each fenestration system in the six cities analyzed.

Figure 6. Annual Energy Cost Comparisons of Six Fenestration Systems in Six Southwestern Cities

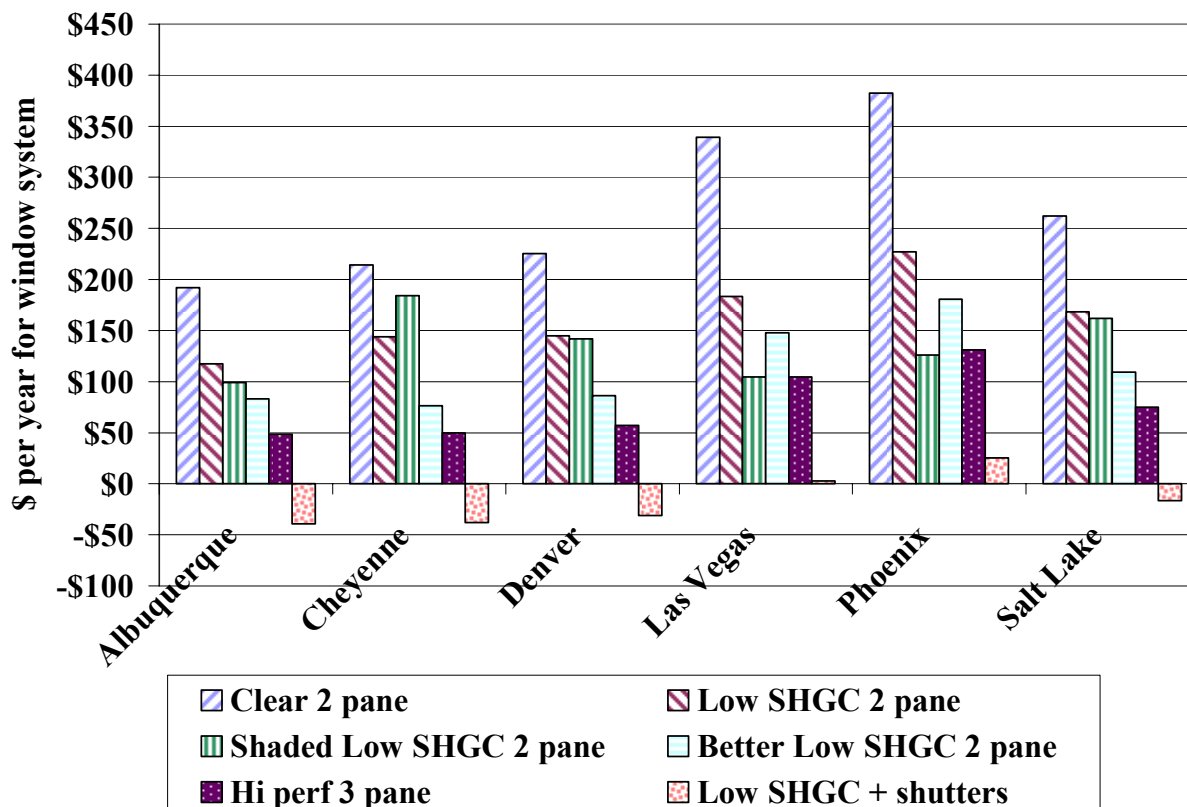

Note that the annual energy cost associated with the windows is cut roughly in half by going from ordinary aluminum frame double pane windows (which are quite common throughout the Southwest) to spectrally-selective low solar gain Low-E glass.

Note that the better low solar gain Low-E system achieves good performance in all cities. In Las Vegas and Phoenix, the shaded system results in even better performance, however. In all climate areas, significant energy improvements result with the high-performance triple-glazed system, and the effect of insulating shutters is even more significant, producing net energy and positive dollar flow in all regions save for Phoenix and Las Vegas, where costs there are quite small.

To better understand the effect of shading, it is useful to take a closer look at the circumstances shown in Tables 4 and 5. Both use exactly the same window system, a spectrally-selective, double-pane insulating glass unit with an overall window system U-factor of 0.5 and a SHGC of 0.4 (low solar gain low-E 2 pane). This window just meets IECC code requirements in hot climates. In the first case, there is no shading. In the second case, there are two foot exterior overhangs that are fixed and exterior obstructions of the same height as the window 20 feet away that represent adjoining buildings or fences. Finally, the shaded case includes interior shades that diminish the SHGC by 20 % in the summer, but which are not used in winter.

Figure 7 shows the detailed performance difference between the shaded and non-shaded window systems in Phoenix and Figure 8 shows the circumstances for Denver.

Figure 7. Annual Energy Costs Comparisons for the Same Window System (U = 0.4; SHGC = 0.4) Shaded and Un-shaded in Phoenix

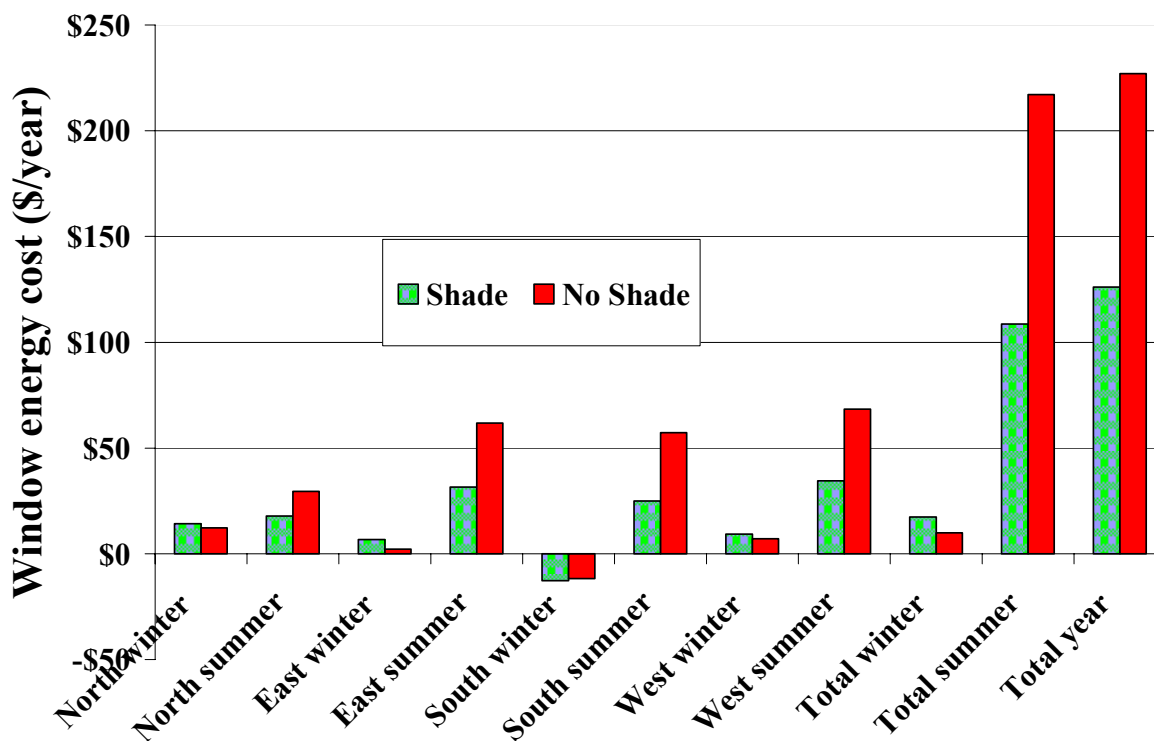
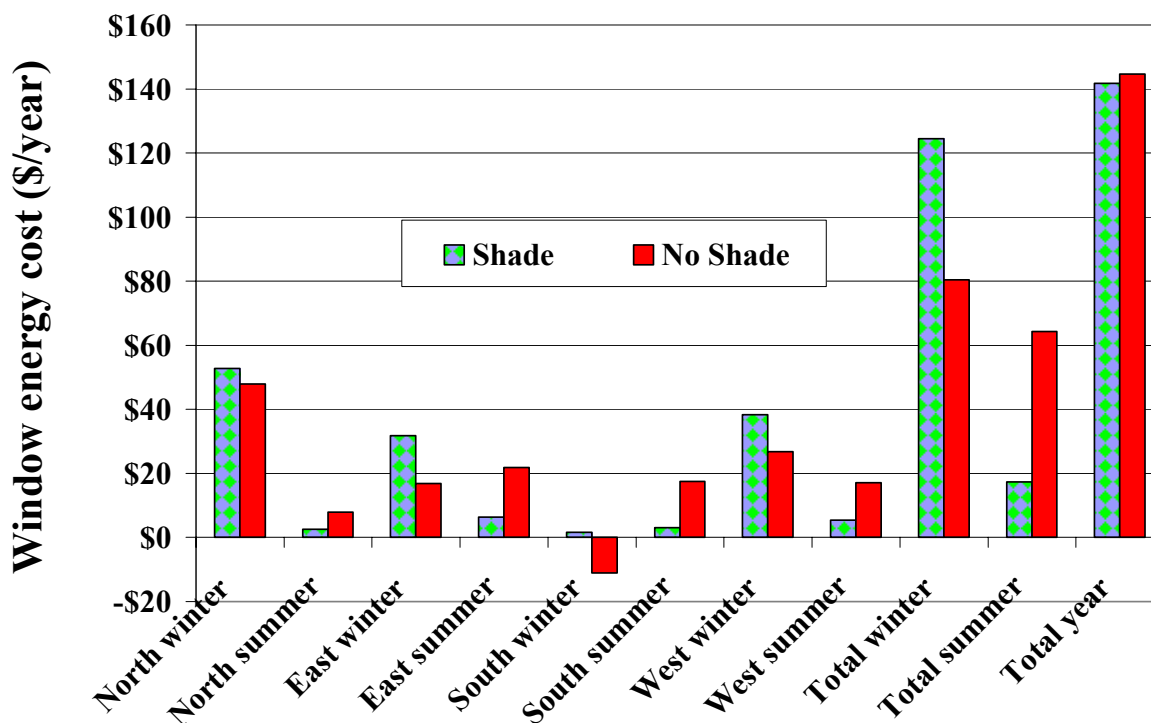

Figure 8. Annual Energy Costs Comparisons for the Same Window System ($U = 0.4$; $SHGC = 0.4$) Shaded and Un-shaded in Denver



In Phoenix, which is dominated by cooling loads, the same window system with overhangs and shading uses 50% less energy (and money) over the cooling season than does the unprotected window system, in spite of its meeting IECC code requirements of a SHGC of 0.4. In the winter, shading has a somewhat deleterious effect on passive solar heating, so overall annual dollar savings due to shading savings in Phoenix are 45% (\$101 per year). In Denver, shading results in a 73% savings in air conditioning energy (as well as 0.38 kW of demand) and costs associated with windows. However, since the summertime climate is much milder, this is almost completely negated by losses in passive solar during the substantially more severe winter. Accordingly, the annual dollar savings are effectively a wash, only \$3 per year. This suggests that a strategy which uses awnings, shutters or similar exterior shading devices that can be stowed when solar gain is desired would result in optimal energy performance.

The combination of high-quality glazing and strategic shading and overhangs matched to the weather region is a winner in all climate areas. That is, very low SHGC windows with devices that provide shading on east, south, and west facades in the cooling season are a good strategy in climates like Phoenix and Las Vegas. Higher SHGC windows on south facades in the other cities in the Southwest (particularly Cheyenne) are more appropriate because of better solar gain in the winter. However, even in northern areas of the Southwest, modest fixed overhangs on the south and shading devices on the east and west used during the cooling season will produce the best energy performance.

Air conditioning use in the Southwest is a leading cause of peak demand problems which cost suppliers of electricity money and ultimately lead to the construction of new power plants. The choice of fenestration systems is causally related to demand problems in the Southwest since utility peaks almost always occur on hot summer afternoons on business days. Figure 9 illustrates the magnitude of demand by city associated with the window systems examined.

Figure 9. Peak Demand of Six Fenestration System in Six Southwestern Cities

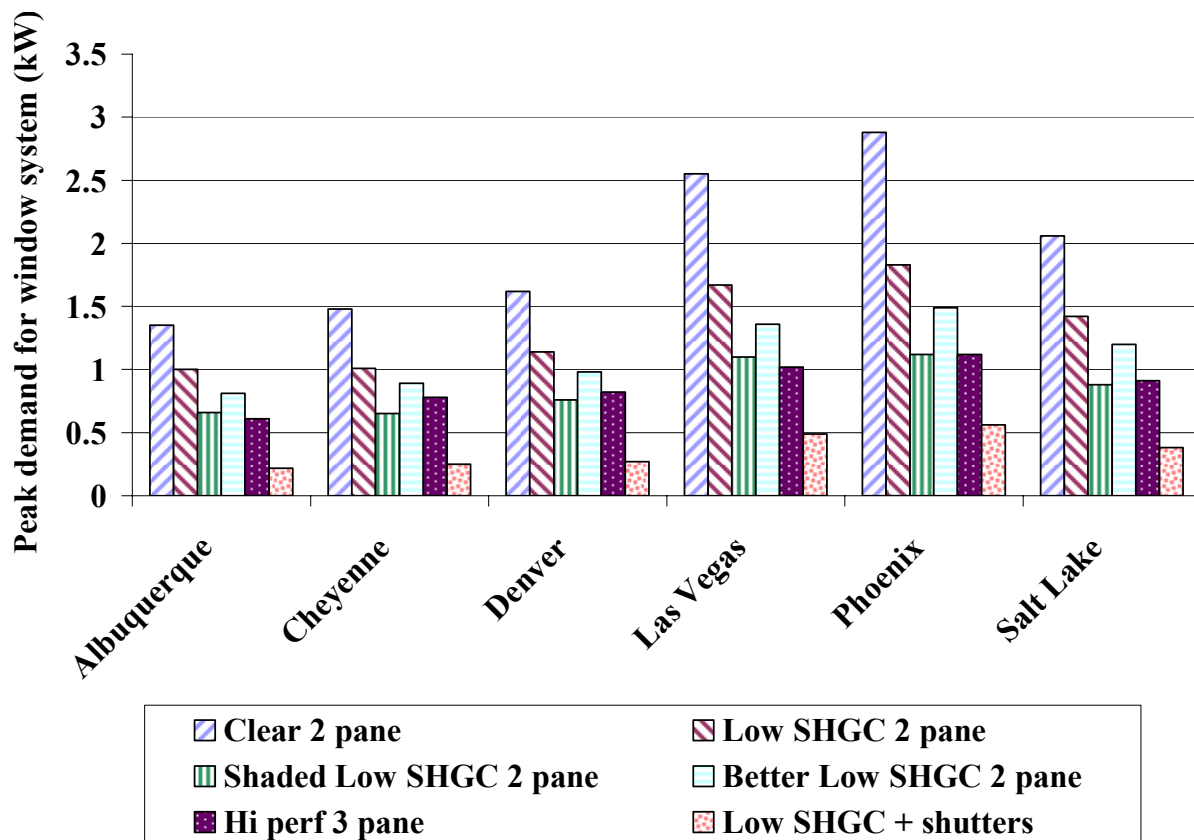

These peak demand figures track overall savings, and are most significant in areas where cooling energy use predominates. Note that the shading option results in lower peak demand than low solar gain windows alone in all climate areas. However, the use of better low solar gain Low-E windows alone can cut peak demand by 1.2 to 1.4 kW in hot climates such as Phoenix and Las Vegas. Even in Denver and Salt Lake City, better low SHGC double pane windows can cut peak cooling demand by 0.6 to 0.9 kW.

In a new home, this reduced demand can also lead to downsized air conditioning units. A one-ton equipment downsizing, which is possible with demand reductions of this size, translates to close to \$500 in first cost savings. Thus, taking advantage of this opportunity can pay for a significant portion of the cost of the window upgrade.

Costs and Benefits

It is clear that there are substantial benefits associated with more efficient glazing—increased comfort in all seasons, as well as savings in electricity, gas, and peak demand—but what are the economics associated with installing more efficient windows? Getting accuracy here is fraught with difficulty since window costs are a powerful function of frame type and associated hardware. Also, first cost depends on who is buying windows (builders, contractors, and consumers get different prices) and the scale of the purchase. Non-thermally broken aluminum windows are at the lower end. Vinyl and thermally-broken aluminum frames are more expensive, followed by high-quality wood, fiberglass, and composites. Since framing is more expensive than glazing, small windows tend to be more expensive on a square foot basis than are larger windows.

Nonetheless, to focus on the cost of energy saved, it is useful to look at the per-square-foot difference in cost between a standard insulating glass unit of, say, 10 to 16 square feet, and a high-quality unit suitable for the Southwest. In Table 8 below, we examine the savings, incremental costs, and simple payback associated with the “better low solar gain low-E two pane” window system (U-factor and SHGC both 0.34) versus the standard insulating glazing unit with non-thermally broken aluminum frames (U-factor 0.79, SHGC 0.68); energy performance of these systems is shown in Tables 3 and 6. An expert on energy-efficient construction reports that the incremental cost for this upgrade ranges from \$2.00 to \$2.50 per square foot (Townsend, 2004). Accordingly, in analyzing paybacks, we assumed \$2.25 per square foot. Note that this cost premium is for both the low-e coating and the better window frame.

Table 8. Savings, Incremental Costs, and Paybacks of Upgrading to Better Low-E Two Pane Window Systems (U-factor 0.34, SHGC 0.34) from Standard Clear Glass Insulating Glass Units (U-factor 0.79, SHGC 0.68)

City	Electric Savings (kWh/yr)	Gas Savings (MBtu/yr)	Demand Savings (kW/yr)	Savings (\$/yr)	Upgrade Cost (\$)	Simple payback (years)
Albuquerque	976	4.37	0.54	\$109	\$675	6.2
Cheyenne	530	10.72	0.59	\$138	\$675	4.9
Denver	835	7.95	0.64	\$139	\$675	4.9
Las Vegas	1859	2.6	1.19	\$191	\$675	3.5
Phoenix	2428	1.68	1.39	\$202	\$675	3.3
Salt Lake	1010	13.26	0.86	\$143	\$675	4.7

The analysis in Table 8 shows that it is cost effective to upgrade to high-performance windows in all parts of the regions. The simple payback period ranges from 3.3 years in Phoenix (mostly because of the improved SHGC) to 6.2 years in Albuquerque’s milder climate.

It is possible to reduce solar gain to even lower levels than those illustrated in the above examples. A new window system achieves a SHGC of 0.2 through a combination of improved coating and moderate tinting (Townsend 2004). Table 9 shows the economics of upgrading from the standard clear glass insulating glass unit to a two-pane window with very low SHGC (U=

0.34; SHGC = 0.20). In this case there is an extra cost of \$1 per square foot for the glass, bringing the cost of the upgrade to \$3.25 per square foot.

Table 9. Savings, Incremental costs, and Paybacks of Upgrading to the Best Two Pane Window Systems (U = 0.34; SHGC = 0.20) from Standard Clear Glass Insulating Glass Units

City	Electric Savings (kWh/yr)	Gas Savings (MBtu/yr)	Demand Savings (kW)	Savings (\$/yr)	Upgrade Cost (\$)	Simple Payback (years)
Albuquerque	1412	-0.34	0.82	\$98	\$975	9.9
Cheyenne	756	3.23	0.75	\$82	\$975	11.8
Denver	1193	1.73	0.9	\$110	\$975	8.9
Las Vegas	2576	-0.8	1.59	\$220	\$975	4.4
Phoenix	3370	-0.57	1.83	\$242	\$975	4.0
Salt Lake	1447	3.49	1.24	\$131	\$975	7.4

In this case, the payback ranges from 4.0 to 11.8 years. Paybacks are marginal in Cheyenne and Albuquerque, owing to mild summers in Cheyenne and overall mild weather in Albuquerque. Note that the best paybacks are in Phoenix (4.0 years) and Las Vegas (4.4 years) where cooling loads dominate and the very low SHGC is most effective.

This prompts the question of whether it is cost effective to upgrade from the better two-pane window system (U = 0.34 and SHGC = 0.34) to the very best low SHGC window system (U = 0.34 and SHGC = 0.20) at an incremental cost of \$1.00 per square foot. Table 10 shows that this is only reasonable in Phoenix and Las Vegas, where paybacks for this option are 7.5 years and 10 years respectively. In other cities, the additional heating cost exceeds the cooling benefit. But this analysis is from the consumer perspective. From the perspective of the electric utility, the peak demand and electricity savings are worth considerable money—on the order of \$75 to \$85 per year in Phoenix and Las Vegas.¹ Thus, this upgrade is even more cost effective from a societal perspective.

Table 10. Savings, Incremental Costs, and Paybacks of Upgrading to the Best Two Pane Window System (U = 0.34; SHGC = 20) from a Better Low Solar Gain Low-E Two Pane Window System (U = 0.34; SHGC = 0.34)

City	Electric Savings (kWh/yr)	Gas Savings (MBtu/yr)	Demand Savings (kW)	Savings (\$/yr)	Upgrade Cost (\$)	Simple Payback (years)
Albuquerque	436	-4.71	0.28	-\$11	\$300	N/A
Cheyenne	226	-7.49	0.16	-\$55	\$300	N/A
Denver	358	-6.22	0.26	-\$29	\$300	N/A
Las Vegas	717	-3.4	0.40	\$28	\$300	10.5
Phoenix	942	-2.25	0.44	\$40	\$300	7.5
Salt Lake	437	-9.77	0.38	-\$12	\$300	N/A

¹ Typical electric utility avoided costs in the Southwest region are \$115 - \$135/kW-yr for peak demand and \$30 - \$35/MWh for electricity.

Market Trends

Unfortunately, many people still consider “double-pane” clear glass windows as energy efficient, and they are still in wide use (DeVito, 2004). In 2003, clear glass represented 40% of the residential windows sold in the U.S. (the same percentage as the mountain states, which includes the Southwest.) Although this is down from 49% in 2001, there is still a great deal of clear glass being installed in housing—and plenty of it in existing residential housing stock. Low-E glass sold in 2003 represents 58% of the total of 5.7 million residential window units sold in the mountain states in 2003, but there are no statistics available reflecting the portion of *low SHGC* Low-E units sold (AAMA/WDMA 2004).

In 2003, vinyl frames amounted to 49% of the total residential market; 26% were aluminum clad wood, 11 % were vinyl clad wood, 6% aluminum without a thermal break, and 4% aluminum with a thermal break. Both wood and aluminum (thermally broken and non-thermally broken) are losing market share at a high rate, primarily to vinyl (AAMA/WDMA 2004). Recent advances in plastics technology has made vinyl windows more resilient to ultraviolet degradation, but their lifetimes are nonetheless likely to be shorter than that of most composites (e.g. wood/plastic or wood/fiberglass extruded shapes).

Emerging Trends among Progressive Builders

McStain Neighborhoods, a progressive builder in Boulder that builds close to 400 new homes per year, routinely uses the better low solar gain low-E two pane glazing on all facades of its new homes (Wilson, 2004). Better performance could be achieved by using windows with higher SHGCs on the south facades, along with modest overhangs on the south and shading devices on the east and west. McStain experimented with using windows of different energy characteristics, but found that crews were not good at getting the appropriate window installed in the right rough opening.

Oakwood Homes of Denver builds over 900 Energy Star homes per year; recent tests of prototype units for a 500 home development had HERS ratings of 88. Oakwood routinely installs windows with a U factor of 0.35 and a SHGC of 0.31 (Carpenter, 2004). Using the assumptions of the analysis above (300 square feet of fenestration evenly divided by facade), this yields an annual energy use due to windows of 587 kWh of electricity and 56 therms of gas for a cost of \$98. Making no changes on the other three facades, if the SHGC of the south-facing windows were changed from 0.31 to 0.7 along with the addition of two foot overhangs over the south-facing glazing, gas use due to windows would be reduced to zero and the annual cost of energy due to windows would drop to \$51, saving \$47 per year for the lifetime of the home. This change would mean that the cost of space conditioning energy due to windows would drop from 19% of the total to 11% of the total. There would be no cost penalty for the change in window characteristics although a small one for overhangs (or awnings).

Charles Lathrem is a Tucson-based custom builder whose homes have won awards for energy efficiency. He installs Andersen 400 series wood frame windows on almost all of his projects. In spite of costing about twice as much as vinyl windows (roughly \$25 per square foot), Lathrem

uses wood frame windows because he and his clients find them more attractive, he can get larger windows with comparatively smaller frames (large vinyl windows require an auxiliary mullion down the center to meet mechanical codes), and wood frames tend to last longer in Tucson's intense sun. He uses "Sun Low-E™" windows on all facades not protected by awnings. These have a U factor of 0.32, a SHGC of 0.26 and a Vt of 0.32. Accordingly, they perform almost as well as the high performance triple pane window system whose energy performance is shown in Table 6. For windows protected by permanent awnings, he uses low solar gain low-E 400 series wood frame windows whose U factor is 0.29, SHGC of 0.36, and Vt of 0.59 (Lathrem, 2004). Since these windows never receive direct beam sunshine, the higher SHGC is of less consequence and Lathrem finds that the substantially higher visual transmittance produces better natural daylighting. Since Tucson's climate requires almost no heating, particularly for the kind of well-insulated, massive homes Lathrem builds, there is little sense in trying to do passive solar heating. Accordingly, keeping SHGC low all around the home is an excellent strategy.

Pulte Homes is the largest home builder in the United States. One hundred percent of its homes in Nevada are ENERGY STAR® dwellings; Pulte has built over 3,600 ENERGY STAR-labeled homes in Nevada since becoming a partner. As of the summer of 2004, all of Pulte's homes in the Las Vegas area use vinyl windows whose U factors are 0.38 and SHGCs are 0.35. These windows cost Pulte about \$10 per square foot (Hodgson, 2004).

Conclusions

Modern window systems with spectrally-selective glazing and low-conductivity frames are now available for use in new homes as well as replacements in the retrofit market. Both are large and important markets. This presents good opportunities throughout the Southwest where window systems that feature low solar heat gain windows can save substantial energy, reduce peak loads appreciably, improve comfort, and achieve these benefits quite cost effectively. Importantly, this would not entail changes to the building design by the builder or changes to homeowner behavior. In homes with ordinary aluminum frame clear double-pane windows (which are still quite prevalent in older homes in the Southwest), the annual energy cost associated with windows is roughly cut in half by upgrading to spectrally-selective low solar gain Low-E glass. This is true in all cities, but is particularly the case in the very hot climates of Phoenix and Las Vegas. Windows with low U-factors are also cost effective, although greater benefits occur in areas with significant winter heating loads.

If a builder or homeowner is considering new windows, the incremental cost to install better performing low solar gain windows is around \$675 for a home with 300 square feet of window area. The incremental cost is for both spectrally-selective coatings and improved window frames. The extra first cost is paid back in 3 to 6 years throughout the Southwest, with faster paybacks in cooling-dominated areas of the region.

Going to very high-performance windows with quite low SHGC and U-factors has an incremental cost of about \$1,000 for the same home. This may be worthwhile from the standpoint of a combination of both comfort and energy savings, but paybacks are proportionally longer. Hotter climate areas with high electric rates like Phoenix and Las Vegas have the best

paybacks (around 4 years) since the energy costs associated with poor-quality windows are highest in these areas.

Insulating shutters both limit conductive losses at night and block direct beam solar tactically during the day. Such systems produce good performance even with windows of middling performance. This suggests that they may be useful in retrofit applications in the Southwest where the existing windows may be poor performers, but are in good mechanical condition. When available (hopefully within a year), costs are expected to be under \$30 per square foot for easily-installable shutters.

During the cooling season, blocking direct beam sunshine from entering a home before it gets to a window is desirable from the standpoint of energy savings, demand savings, and comfort. It is most easily achieved in the case of south façades, where horizontal awnings or overhangs extending several feet over the windows are adequate during the heat of the summer, yet do not negatively effect passive solar heating performance in winter. East and (especially) west-facing facades pose more difficulties since sun angles are quite low. Some combination of fins, exterior shades or shutters, fencing, and foliage is usually worth the trouble. However, windows with very low SHGCs are always appropriate on east and west facades, save in climates like Cheyenne where summers are quite mild.

In short, high-performance, low solar heat gain windows can greatly reduce energy costs and peak electric demand in new and existing homes throughout the Southwest region—and do so quite cost effectively. In addition, employing well-designed shading devices can lead to even lower energy costs and peak demand, but with greater first costs and longer payback periods. Although it is not presently practiced in the building industry, the combination of low solar gain windows and automated insulating shutters could entirely eliminate the substantial energy cost associated with windows in all parts of the Southwest, but at significantly greater cost.

References

AAMA/WDMA. 2004. Study of the U.S. market for windows, doors, and skylights.

Carmody, J., S. Selkowitz and L. Heshong. 1996. Residential Windows: A Guide to New Technologies and Energy Performance, W.W. Norton & Company.

Carpenter, D. 2004. Personal communication with Don Carpenter of Oakwood Homes, July 30.

DeVito, E. 2004. Personal communication with Eric DeVito of Brickfield, Burchette, Ritts & Stone, PC, August 30.

Efficient Windows Collaborative, www.efficientwindows.org . Contact Alison Tribble, EWC Program Administrator, Alliance to Save Energy, 1200 18th Street N.W., Suite 900, Washington, D.C. 20036, phone: 202-530-2231, email: ewc@ase.org.

Hodgson, N. 2004. Personal communication with Nat Hodgson of Pulte Nevada, August 2.

Lathrem, C. 2004. Personal communication with Charles Lathrem of Tucson, AZ, August 2.

Townsend, B. 2004. Personal communication with Brad Townsend of Masco Contractor Services, Environments for Living, Phoenix, AZ, August 5.

Wilson, J. 2004. Personal communication with Justin Wilson of McStain Neighborhoods, Boulder, CO, July 2004.